

**We focus on
folding
furniture**

Folding Furniture

- Folding rectangular table
- Folding round table
- Folding square table
- Folding lift table
- Folding TV table
- Folding chair
- Folding stool



Furniture of Contents

01 / Company Profile

P₀₁

02 / Folding Table

P₀₂₋₂₅

03 / Folding Chair

P₂₆₋₃₁

04 / Folding Stool

P₃₂₋₃₃



FOLDING TABLE

60/80/110CM



PRODUCT MATERIAL

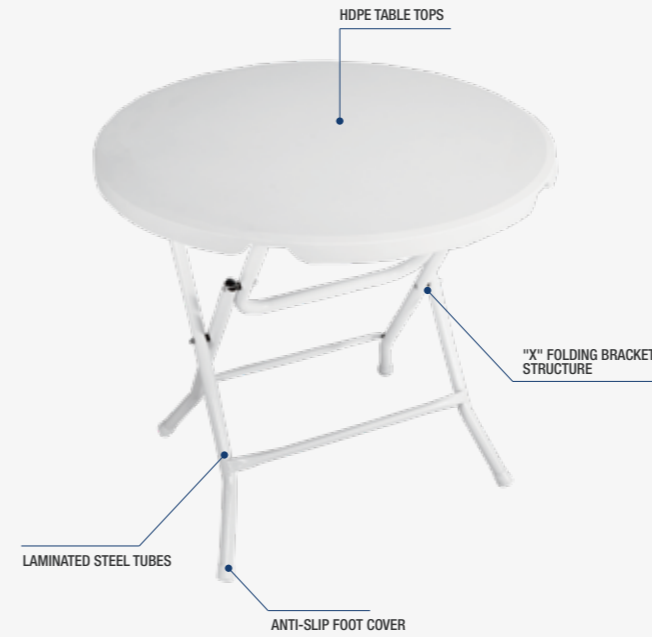

PRODUCT DETAILS

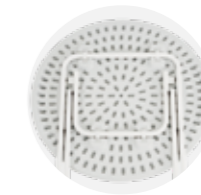

HONEYCOMB PANEL STRUCTURE



"X" FOLDING BRACKET STRUCTURE



ROUNDED CORNERS

COLOURS AVAILABLE



WHITE



GREY



BLACK

PRODUCT PARAMETERS

MODEL	BJ-ZY60
FRAME	∅25X1.0MM
G.W	4.32KG
MEAS	67*6.5*104CM

EXPANDED STATE



FOLDED STATE

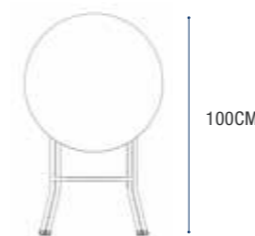

MODEL	BJ-ZY80
FRAME	∅25X1.0MM
G.W	6.3KG
MEAS	86*6*105CM

EXPANDED STATE



FOLDED STATE



MODEL	BJ-ZY110
FRAME	∅25X1.0MM
G.W	7.5KG
MEAS	81*6*141CM

EXPANDED STATE

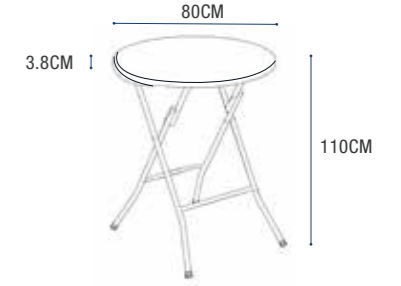

FOLDED STATE

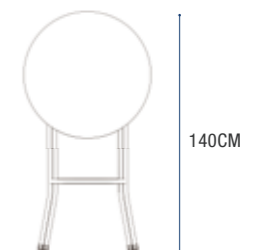

FOLDING TABLE

122-183CM



PRODUCT MATERIAL

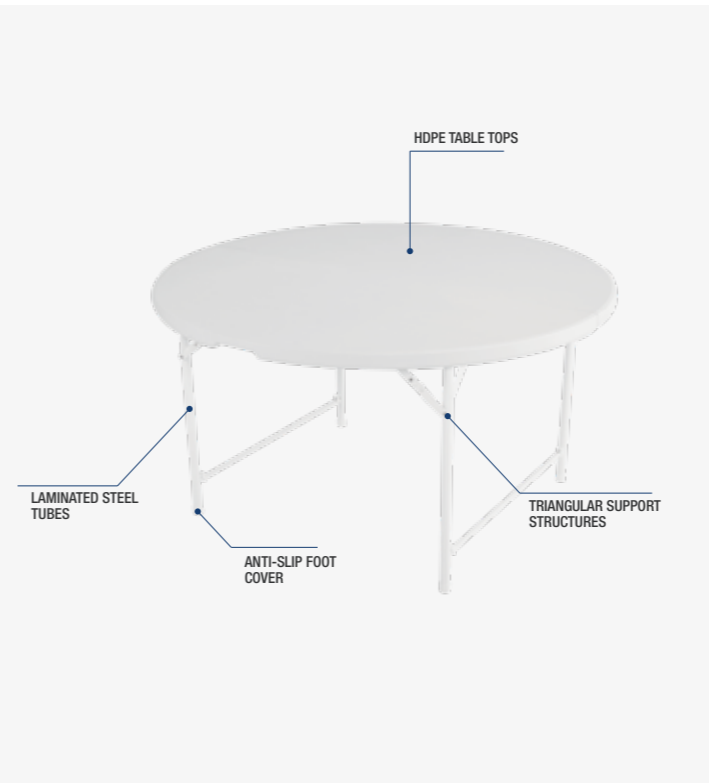

PRODUCT DETAILS

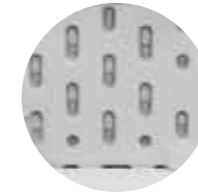

HONEYCOMB PANEL STRUCTURE



CARRYING STRAP DESIGN



TRIANGULAR STABLE STRUCTURE



SAFETY BUCKLE DESIGN



CLIP CONNECTION DESIGN

COLOURS AVAILABLE



WHITE



GREY



BLACK

ADVANTAGES



Ours

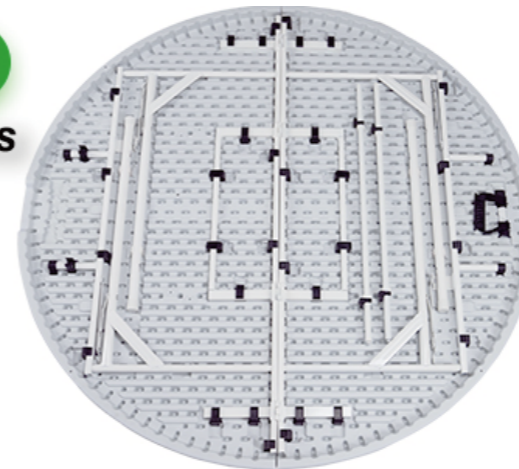

New Designed Full-Buckles Structure

Use solid buckles to secure the metal frame instead of flimsy screws



Others

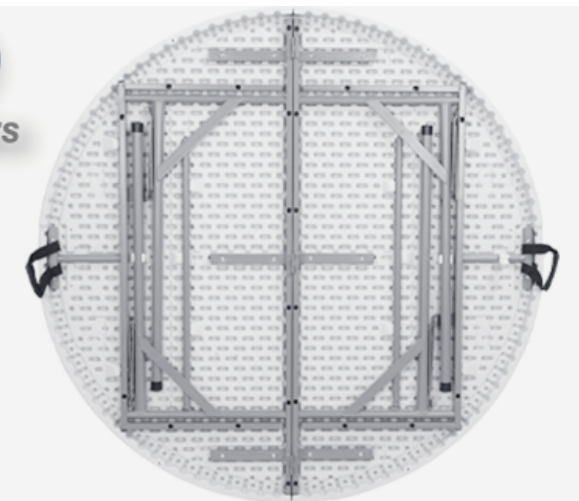

Flimsy Screws Structure

Screws are easy to loose in daily use & unable to tighten any more Result in the falling apart of the table

PRODUCT PARAMETERS

MODEL	BJ-ZY122
FRAME	Φ25X1.0MM
G.W	15.3KG
MEAS	133*10*67CM

▼ EXPANDED STATE

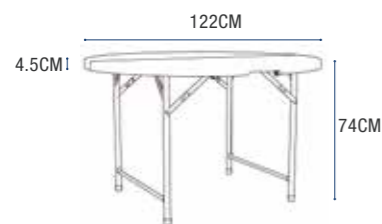

▼ FOLDED STATE



MODEL	BJ-ZY135
FRAME	Φ25X1.0MM
G.W	17.3KG
MEAS	148*10*76CM

▼ EXPANDED STATE



▼ FOLDED STATE



MODEL	BJ-ZY152
FRAME	Φ28X1.0MM
G.W	22.6KG
MEAS	165*10*84CM

▼ EXPANDED STATE

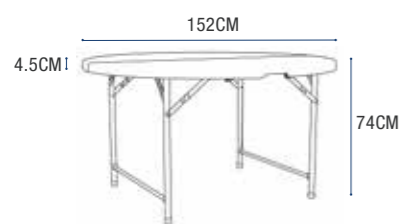

▼ FOLDED STATE



MODEL	BJ-YZ165
FRAME	Φ32/1.0MM
G.W	24.56KG
MEAS	176*12*88CM

▼ EXPANDED STATE



▼ FOLDED STATE



MODEL	BJ-YZ183
FRAME	Φ32/1.0MM
G.W	32.25KG
MEAS	195*12*99CM

▼ EXPANDED STATE



▼ FOLDED STATE



PRODUCT PARAMETERS

MODEL	BJ-ZC152
FRAME	Φ25X1.0MM
G.W	10.81KG
MEAS	76.5*10.5*85CM

▼ EXPANDED STATE

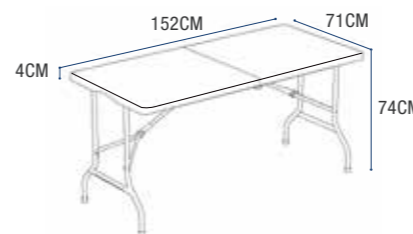

▼ FOLDED STATE

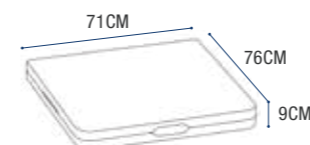

MODEL	BJ-ZC240
FRAME	Φ28X1.0MM
G.W	18.14KG
MEAS	135*85*10.8CM

▼ EXPANDED STATE

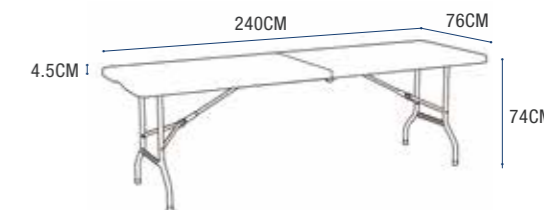

▼ FOLDED STATE

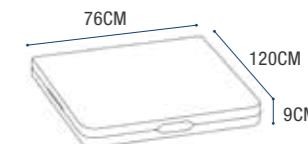

FOLDING TABLE

180/183CM



PRODUCT MATERIAL

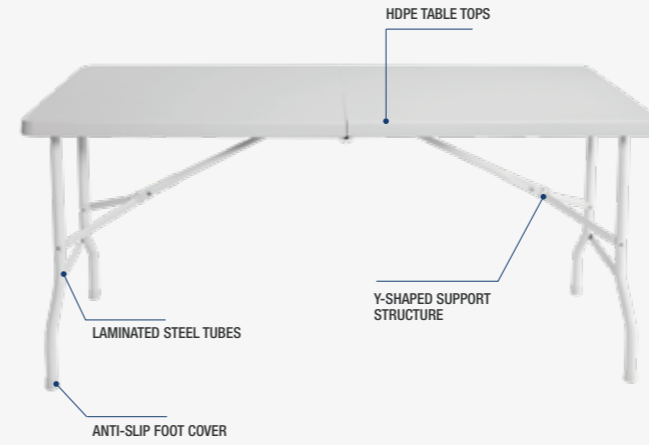

PRODUCT DETAILS



HONEYCOMB PANEL STRUCTURE



CARRYING STRAP DESIGN



THICKENED PANELS



ANTI-ARCH LATCHING DESIGN

COLOURS AVAILABLE



WHITE



GREY



BLACK

PRODUCT PARAMETERS

MODEL	BJ-ZC180
FRAME	Φ25X1.0MM
G.W	12.6KG
MEAS	101*81*9.6CM

EXPANDED STATE

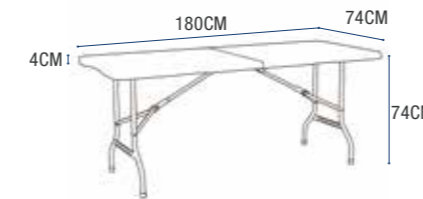

FOLDED STATE

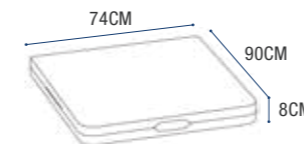

MODEL	BJ-183C
FRAME	Φ28X1.0MM
G.W	15.5KG
MEAS	188*82.5*6CM

EXPANDED STATE

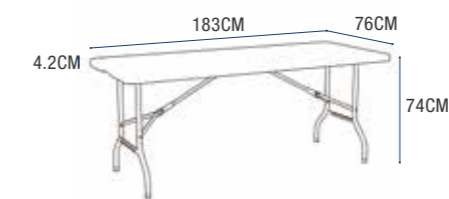

FOLDED STATE



MODEL	BJ-ZC183
FRAME	Φ25X1.0MM
G.W	14.3KG
MEAS	102*82.5*9.6CM

EXPANDED STATE

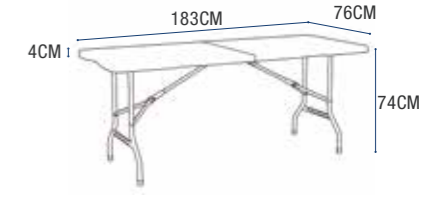

FOLDED STATE

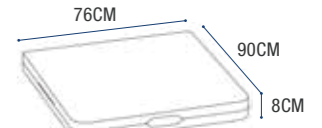

FOLDING TABLE 122CM



PRODUCT MATERIAL

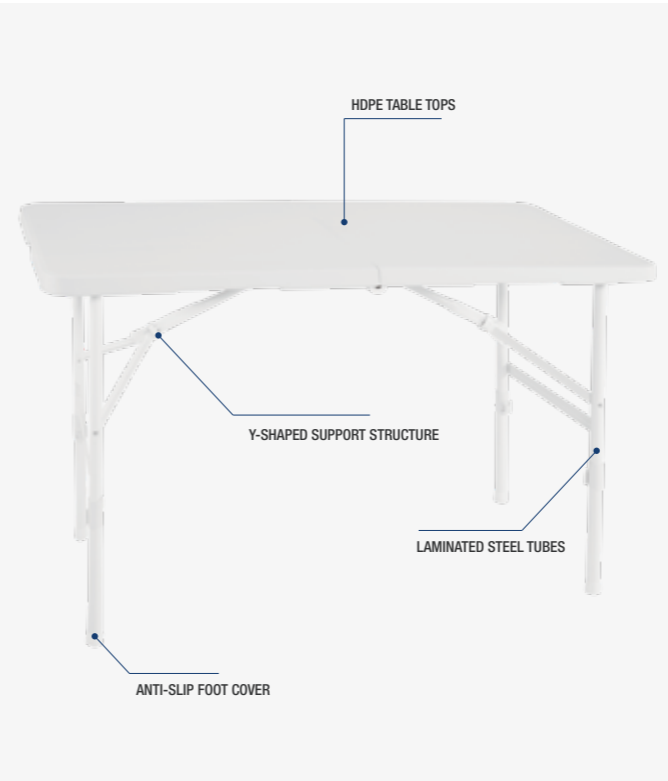

PRODUCT DETAILS

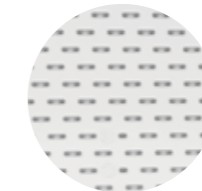

HONEYCOMB PANEL STRUCTURE



CARRYING STRAP DESIGN



DESIGN OF THE GEAR LOCKING STRUCTURE



TRIANGULAR STABLE STRUCTURE



ANTI-ARCH LATCHING DESIGN

COLOURS AVAILABLE



PRODUCT PARAMETERS

MODEL	BJ-122C
FRAME	Φ25X1.0MM
G.W	9.24KGS
MEAS	128*6*67CM

EXPANDED STATE

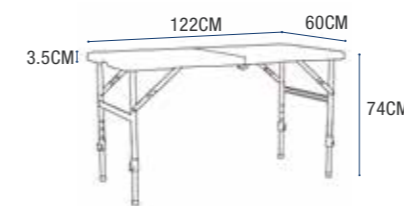

FOLDED STATE

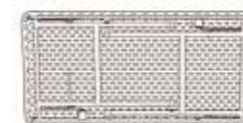

MODEL	BJ-ZC122
FRAME	Φ25X1.0MM
G.W	8.62KGS
MEAS	67*9*72CM

EXPANDED STATE

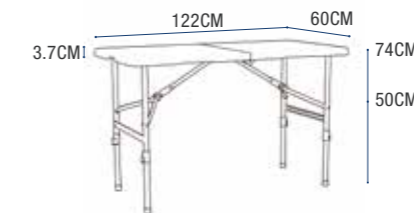

FOLDED STATE

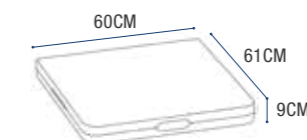

NEW

MODEL	BJ-ZCSJ122
FRAME	Φ25X1.0MM
G.W	8.65KGS
MEAS	67*9*72CM

EXPANDED STATE

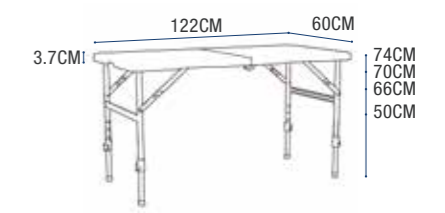

FOLDED STATE

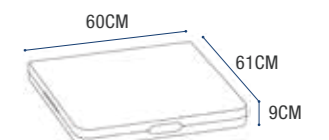

FISH CLEANING TABLE



PRODUCT MATERIAL



PRODUCT PARAMETERS

MODEL	BJ-SYZ108
N.W	12.2KG
G.W	14KG
MEAS	117*64*9CM

COLOURS AVAILABLE



PRODUCT SIZE

▼ EXPANDED STATE



▼ FOLDED STATE



PRODUCT DETAILS



MEASURING MARKS



WATERPROOF TABLETOP



KNIFE GROOVES



PREMIUM WATER GUN



STAINLESS STEEL FAUCET

FOLDING TABLE

86CM



PRODUCT MATERIAL

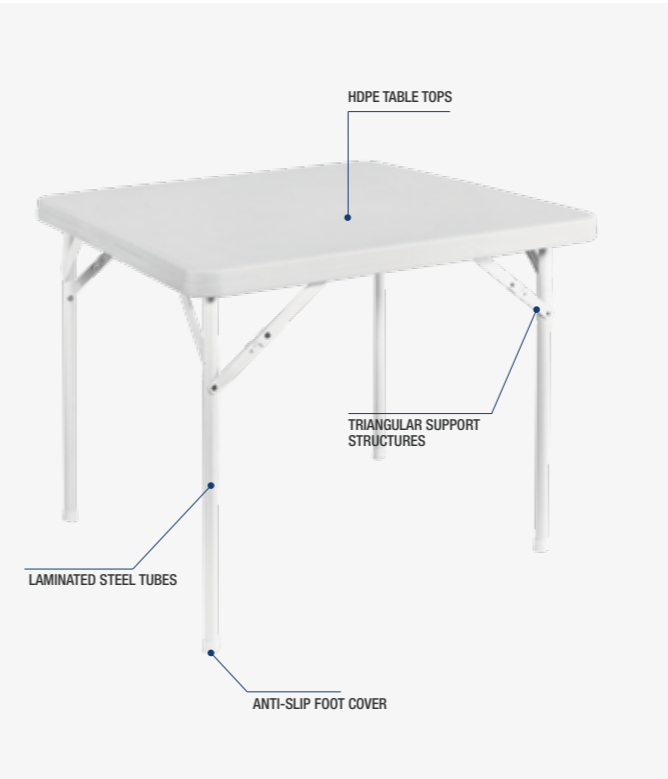

PRODUCT DETAILS

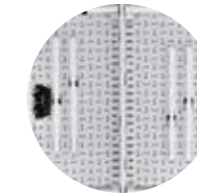

HONEYCOMB PANEL STRUCTURE



ANTI-ARCH LATCHING DESIGN



CARRYING STRAP DESIGN



DESIGN OF THE GEAR LOCKING STRUCTURE

COLOURS AVAILABLE



WHITE



GREY



BLACK

PRODUCT PARAMETERS

MODEL	BJ-F86
FRAME	Φ25X1.0MM
G.W	9.8KG
MEAS	95*6*95CM

EXPANDED STATE

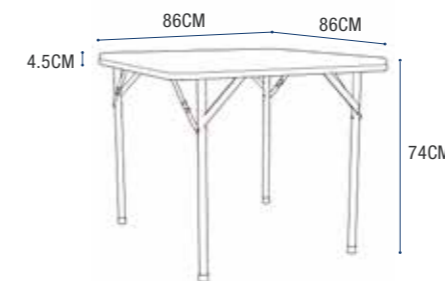

FOLDED STATE



MODEL	BJ-ZF86
FRAME	Φ25X1.0MM
G.W	9.6KG
MEAS	93*54*8.7CM

EXPANDED STATE

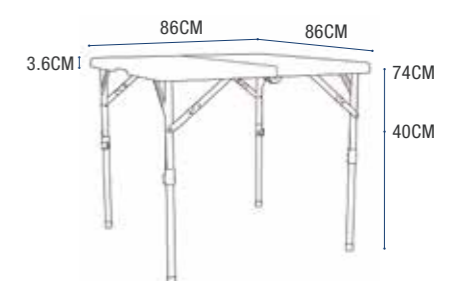

FOLDED STATE



DOMINO TABLE 90CM



PRODUCT MATERIAL

PRODUCT PARAMETERS

MODEL	BJ-F90MJ
FRAME	Φ28X1.0MM
G.W	11.3KG
MEAS	95.5*6.5*96CM

COLOURS AVAILABLE

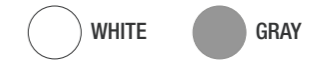

PRODUCT SIZE

EXPANDED STATE

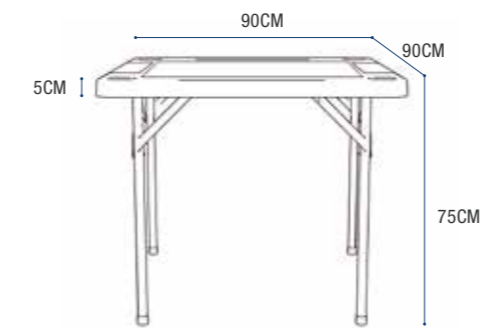

FOLDED STATE

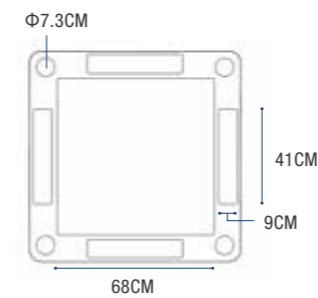

PRODUCT DETAILS



EASY TO PUSH CHIP TRAYS

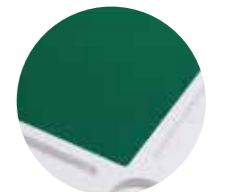

NOISE REDUCTION GREEN TABLE COVER



CONVENIENT CUP HOLDERS

LIFTING TABLE

50/76CM



PRODUCT MATERIAL

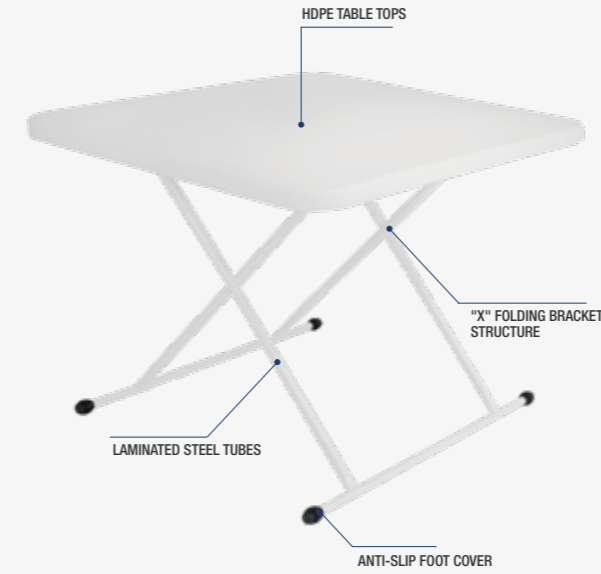

PRODUCT DETAILS

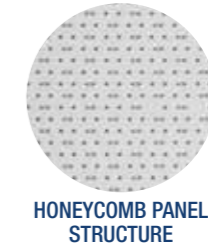

COLOURS AVAILABLE



PRODUCT PARAMETERS

MODEL	BJ-ZFSJ7676
FRAME	Φ28X1.0MM
G.W	6.3KG
MEAS	88*8*78.5CM

EXPANDED STATE

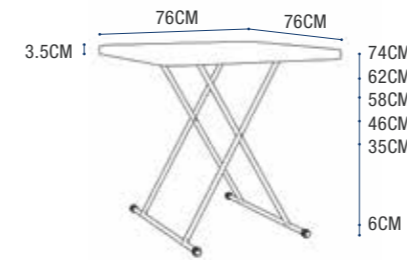

FOLDED STATE



MODEL	BJ-CFSJ7650
FRAME	Φ28X1.0MM
G.W	4.68KG
MEAS	52.5*7*98CM

EXPANDED STATE



FOLDED STATE



LIFTING TABLE

65/45CM



PRODUCT MATERIAL

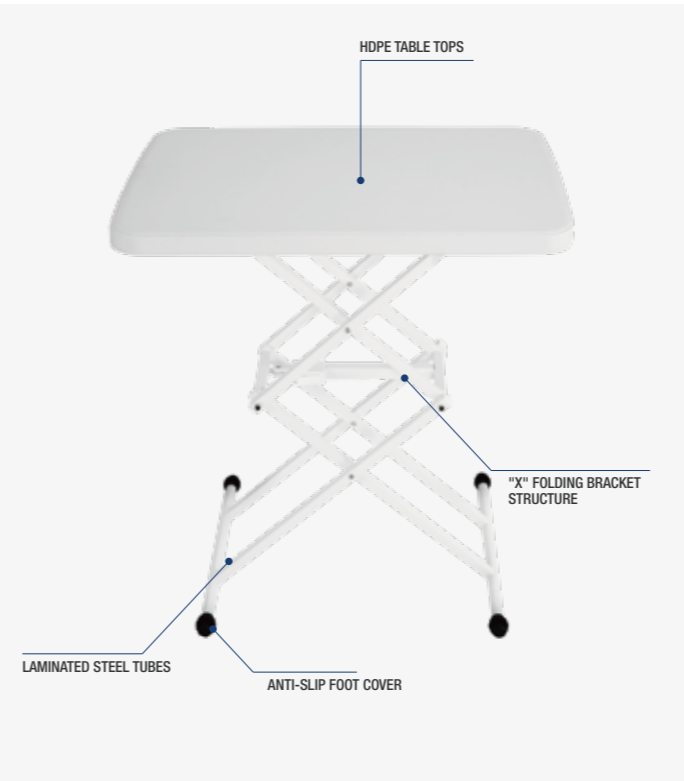

PRODUCT DETAILS



HONEYCOMB PANEL STRUCTURE



THICKENED PANELS



"X" FOLDING BRACKET STRUCTURE



ANTI-SLIP FOOT COVER

COLOURS AVAILABLE



WHITE



GREY



BLACK

PRODUCT PARAMETERS

NEW

MODEL	BJ-YTSJ6545
FRAME	Φ19X1.0MM
G.W	4.78KG
MEAS	47.5*8.5*74CM

EXPANDED STATE

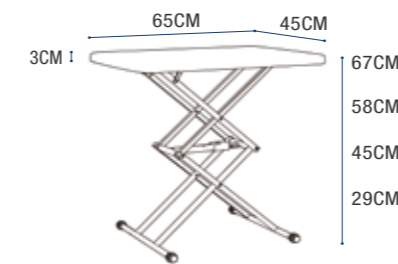

FOLDED STATE



MODEL	BJ-CFSJ6545
FRAME	Φ19X1.0MM
G.W	4.0KG
MEAS	47*8*86CM

EXPANDED STATE

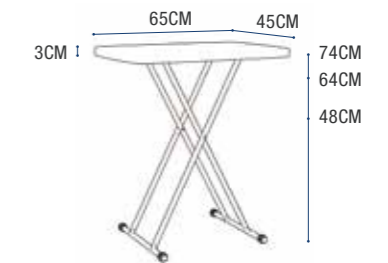

FOLDED STATE



TV TABLE 5240



PRODUCT MATERIAL

PRODUCT PARAMETERS

MODEL	BJ-ZZ5240
QTY	6PCS/CTN
G.W	20KGS
MEAS	54.5*46*44.5CM

COLOURS AVAILABLE

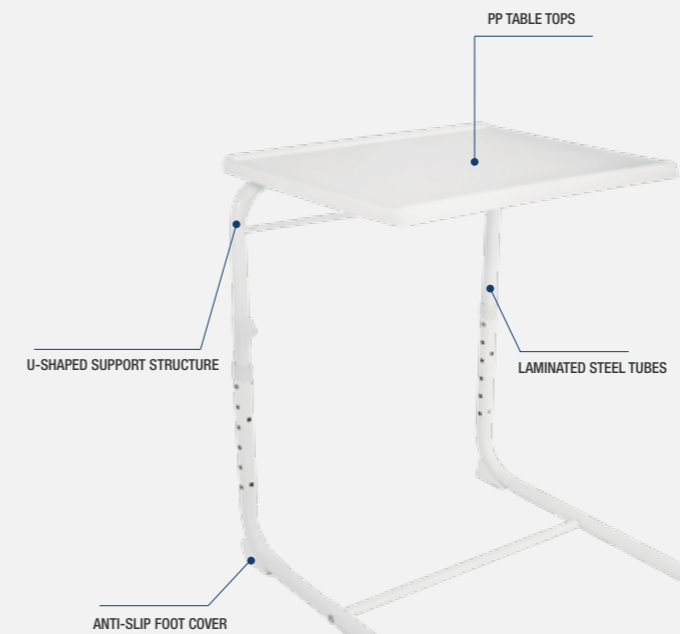

PRODUCT SIZE

▼ EXPANDED STATE

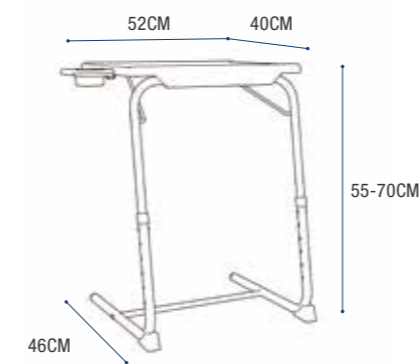

▼ FOLDED STATE



PRODUCT DETAILS



FUNCTIONAL CUP HOLDERS



GEAR ADJUSTMENT



THICKER AND THICKER MATERIAL



THICKENED PANELS

TV TABLE 5643



PRODUCT MATERIAL

PRODUCT PARAMETERS

MODEL	BJ-ZZ5643
QTY	1PCS/CTN
G.W	3.9KG
MEAS	45.5*10.5*59.5CM

COLOURS AVAILABLE



PRODUCT SIZE

▼ EXPANDED STATE



▼ FOLDED STATE



PRODUCT DETAILS

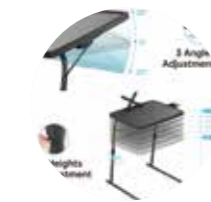

6 HEIGHTS ADJUSTMENT



360° CUP HOLDER



LARGE TABLE TOP



DESIGN OF BOOK STAND

FOLDING CHAIR

101/102



PRODUCT MATERIAL



PRODUCT DETAILS



COMFORTABLE CURVED BACKREST

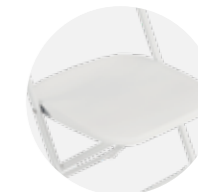

WIDE STOOL TOP



"X" FOLDING BRACKET STRUCTURE

COLOURS AVAILABLE



WHITE



BLACK



RED

PRODUCT PARAMETERS

MODEL	BJ-YZ101
QTY	10PCS/CTN
MEAS	98.5*33*47CM
G.W	32.7KGS

▼ EXPANDED STATE



▼ FOLDED STATE

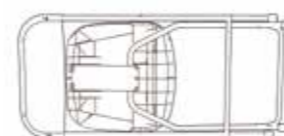

MODEL	BJ-YZ102
QTY	10PCS/CTN
MEAS	106*34*48CM
G.W	34.5KGS

▼ EXPANDED STATE

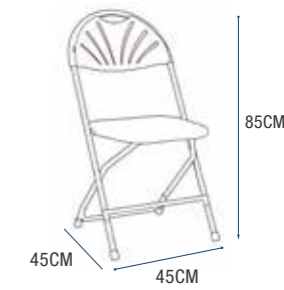

▼ FOLDED STATE

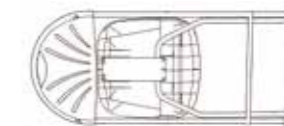

FOLDING CHAIR

101/104



PRODUCT MATERIAL

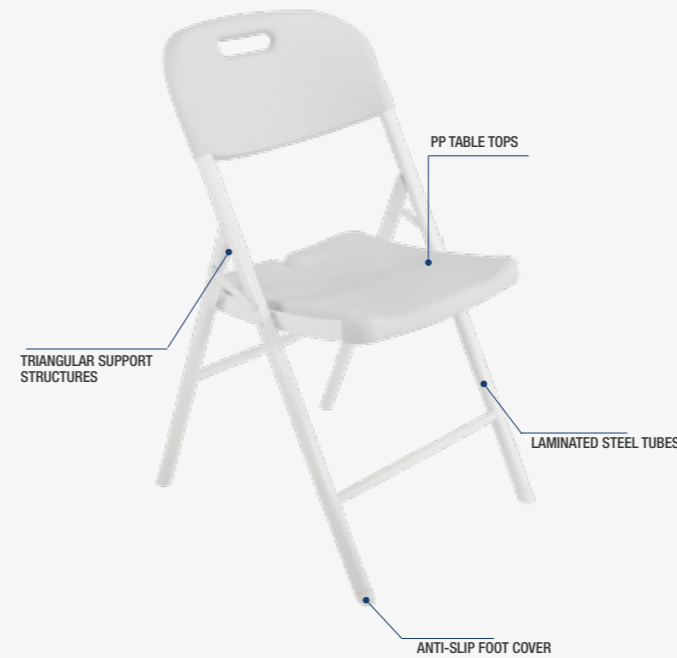

PRODUCT DETAILS



COMFORTABLE CURVED BACKREST



WIDE STOOL TOP



TRIANGULAR SUPPORT STRUCTURES

COLOURS AVAILABLE



WHITE



BLACK

PRODUCT PARAMETERS

MODEL	BJ-YZ103
QTY	4PCS/CTN
G.W	16.6KG
MEAS	106*31*46.5CM

EXPANDED STATE



FOLDED STATE

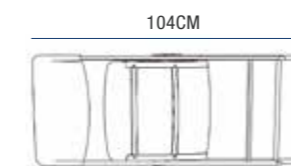

MODEL	BJ-YZ104
QTY	4PCS/CTN
G.W	13.85KG
MEAS	113*27*48CM

EXPANDED STATE

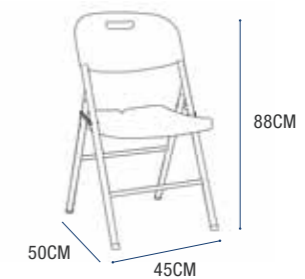

FOLDED STATE

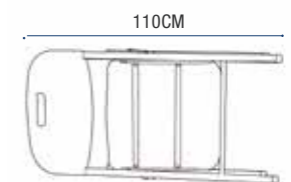

FOLDING CHAIR

107



PRODUCT MATERIAL

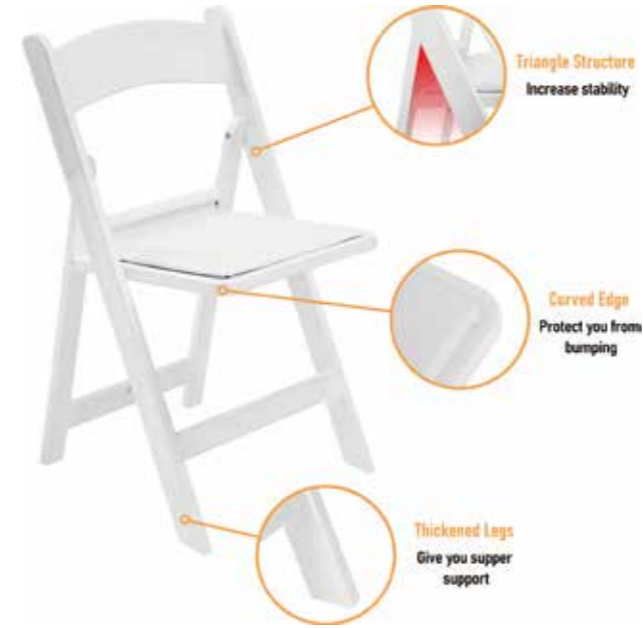

PRODUCT PARAMETERS

MODEL	BJ-YZ107
QTY	4PCS/CTN
G.W	20.12KGS
MEAS	90*47*24CM

COLOURS AVAILABLE



PRODUCT SIZE

▼ EXPANDED STATE



▼ FOLDED STATE



PRODUCT DETAILS



UPHOLSTERED VINYL PADDED SEAT
SMOOTH & SOFT TOUCH



REMOVABLE EASY
TO WASH



110° ERGONOMIC DESIGN

FOLDING STOOL

105



PRODUCT MATERIAL

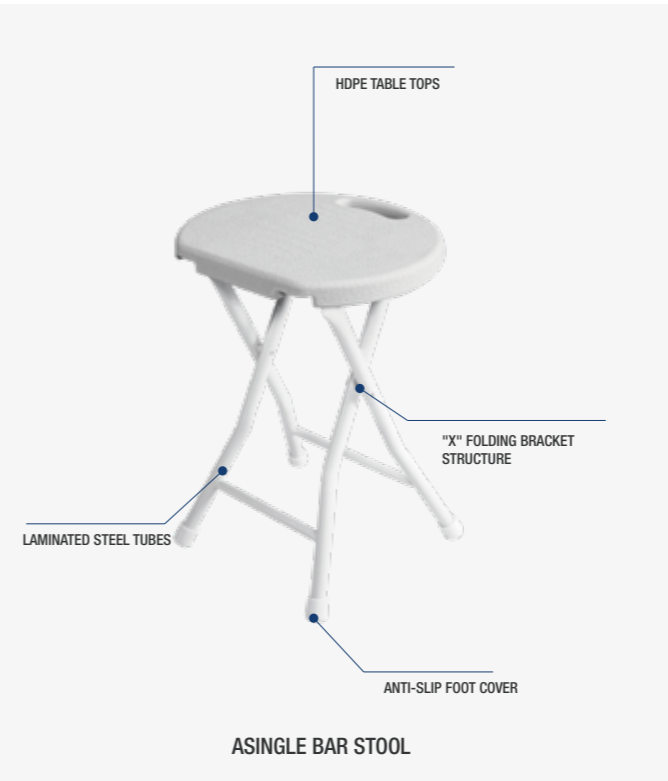

PRODUCT PARAMETERS

MODEL	BJ-DZS105
QTY	6PCS/CTN
G.W	9.4KG
MEAS	72*34*32CM

▼ EXPANDED STATE



▼ FOLDED STATE

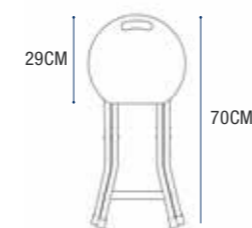

PRODUCT DETAILS



ANTI-SLIP
TIGER SKIN DESIGN



"X" FOLDING BRACKET
TRUCTURE



ANTI-SLIP FOOT COVER

COLOURS AVAILABLE



PRODUCT PARAMETERS

MODEL	BJ-DZD105
QTY	6PCS/CTN
G.W	10.1KG
MEAS	72*34*32CM

▼ EXPANDED STATE



▼ FOLDED STATE

